





PARTS

<p>① Post w/Standoff Tip</p> 	<p>② Base</p> 	<p>③ Graphic</p> 	<p>④ Bolt</p> 	<p>⑤ Allen Wrench</p> 
---	---	---	---	---

ASSEMBLY INSTRUCTIONS

STEP 1

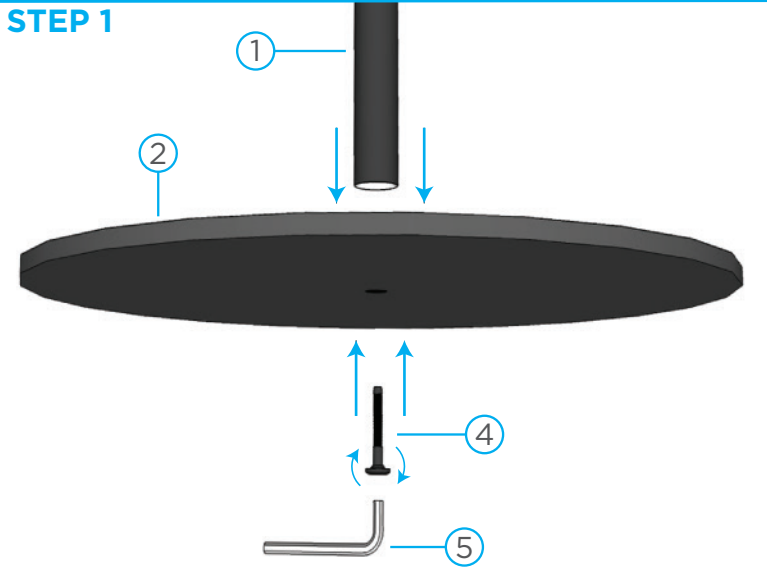

Insert the Bolt⁴ through the bottom of the Base² and into the threaded insert of the Post¹. Tighten the Bolt⁴ with an Allen Wrench⁵ until the Base² and Post¹ are securely connected together.

STEP 2

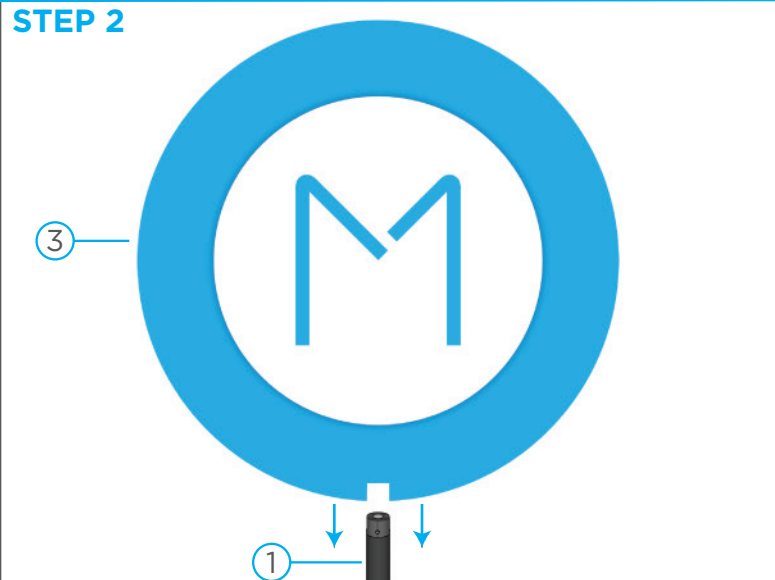

Attach the Graphic³ by fully resting it onto the Standoff Tip of the Post¹. (The post can hold one or two separate graphics)

STEP 3

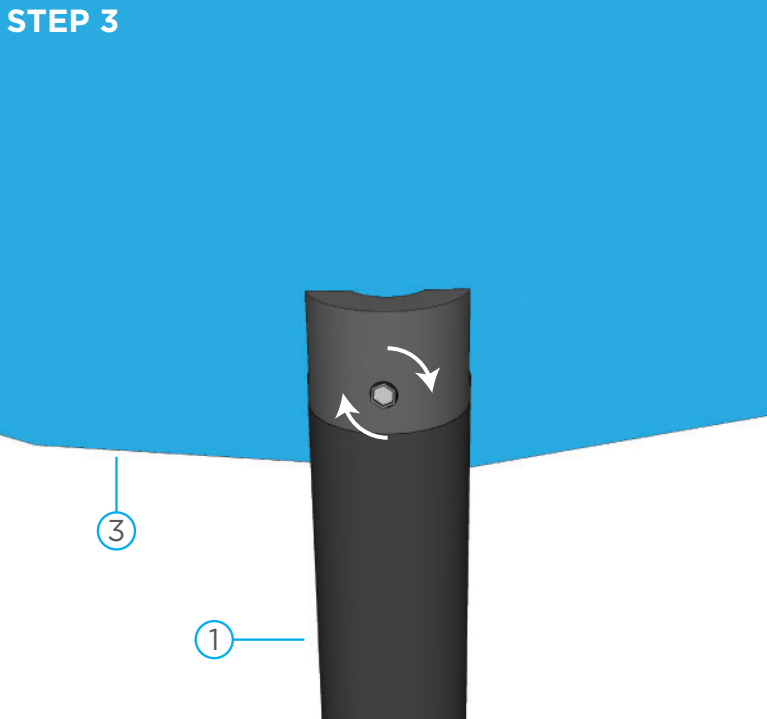

Secure the Graphic(s)³ to the Post¹ by tightening the screw on the Standoff with an Allen Wrench⁵ until the Graphic(s)³ are firmly attached.



The Lollipop Stand is now ready for display.