







FRAME PARTS LIST

①  Allen Wrench 1 pc	②  Bolts 2 pc	③  Middle Bar (with T connectors) 1 pc	④  Base 1 pc
⑤  Silver Bars (without connectors) 4 pc		⑥  Top Bar (with connectors) 1 pc	

FRAME ASSEMBLY INSTRUCTIONS

STEP 1

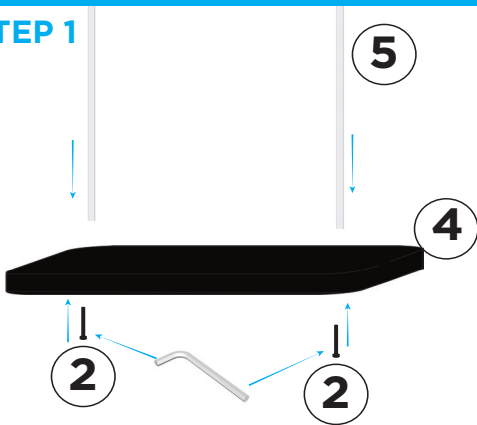

Insert bolts through base from bottom, and connect to threaded upright bars using the supplied 4mm hex key. Do not tighten completely.

STEP 2

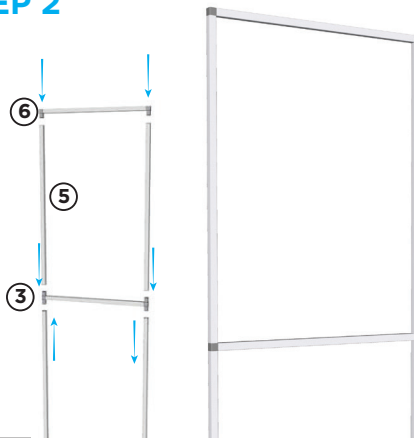

Insert the top bar connectors into the top and middle section of the upright bars.

STEP 3

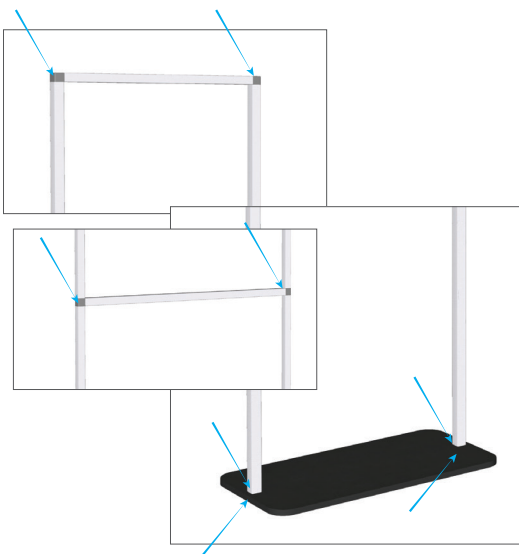

Make certain all connections are tight - use mallet if needed.

STEP 4

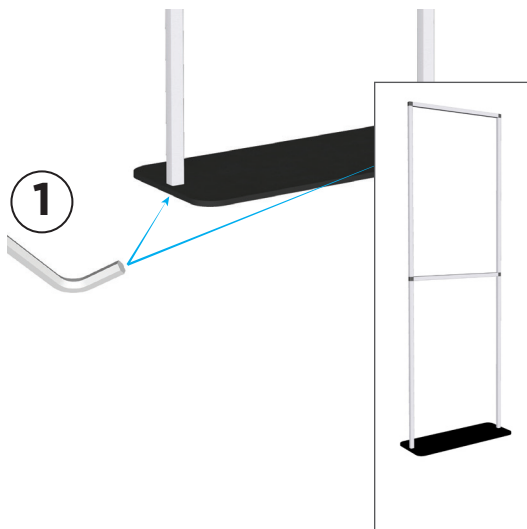

Hand-tighten the connector bolts completely using hex key.

GRAPHIC INSTALLATION

STEP 1

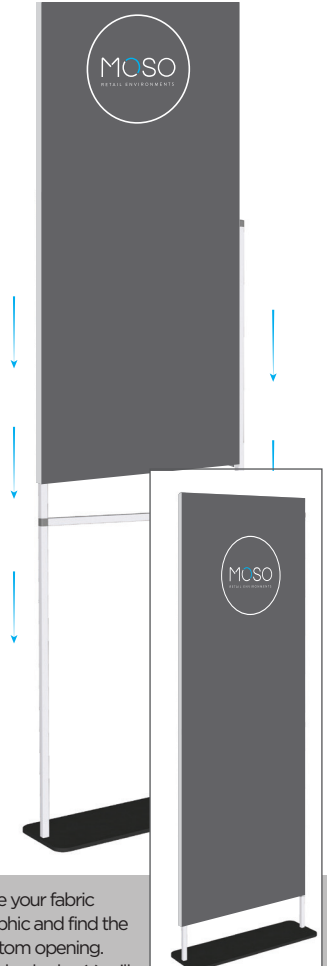

Take your fabric graphic and find the bottom opening. Stitched edge(s) will line up to the narrow edge of the frame.

Carefully pull the graphic over the entire structure like pulling on a sock or pillowcase. When the graphic is all the way on, smooth out wrinkles with your fingers and align seams to edges of the frame

On tall frames, a helper to hold the fabric for you is **highly recommended**.

You may also need a step stool or step ladder to get the fabric started over the top of the frame.